

69-74 PONTIAC S-DRIVE DIMENSIONS

MS117-65, MS117-66 & MS117-67

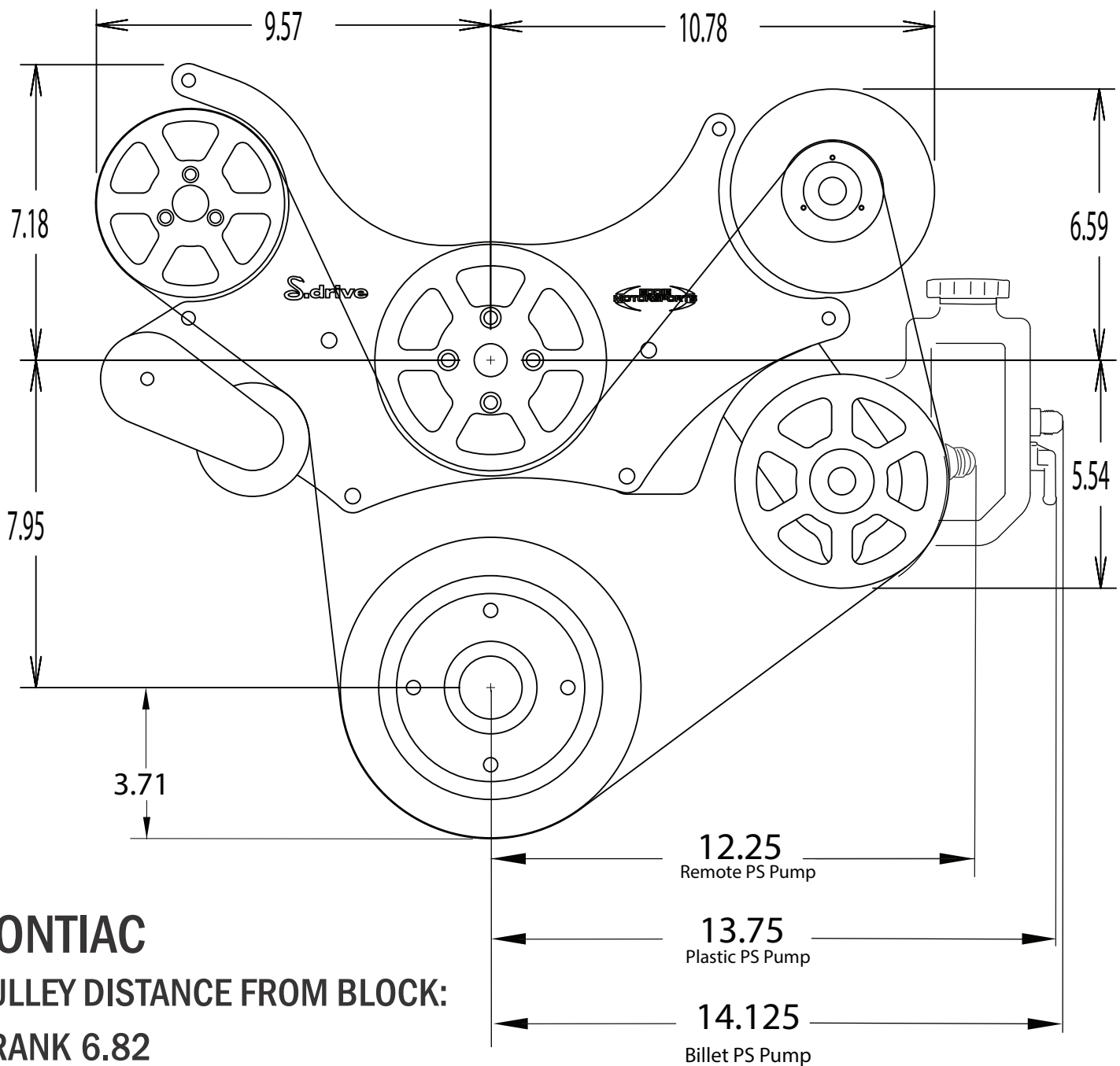

PONTIAC

PULLEY DISTANCE FROM BLOCK:

CRANK 6.82

POWER STEERING 6.94

ALTERNATOR 7.07

WATER PUMP 7.08

A/C COMPRESSOR 8.05

TENSIONER 7.69

